

NO.	DESCRIPTIONS	MAT'L	Q'TY	WEIGHT KG		REMARKS
				UNIT	TOTAL	
	RAIL CLAMP DOUBLE		1		0.3	
1	CLAMP UPPER	S20C	1			
2	CLAMP LOWER	S20C	1			
3	BOLE.NUT	S20C	1			

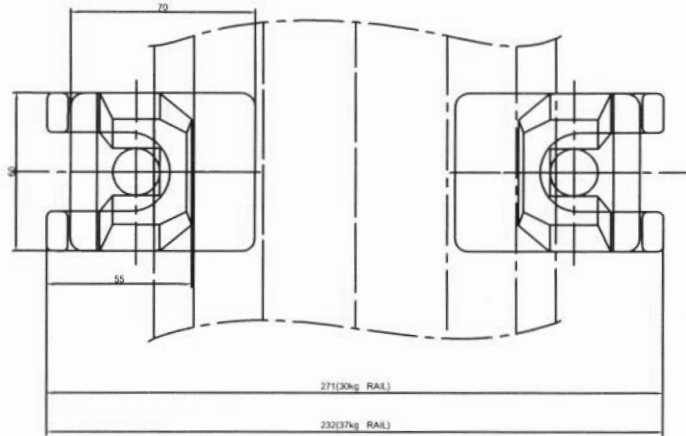

Rail clamp Double Assembly

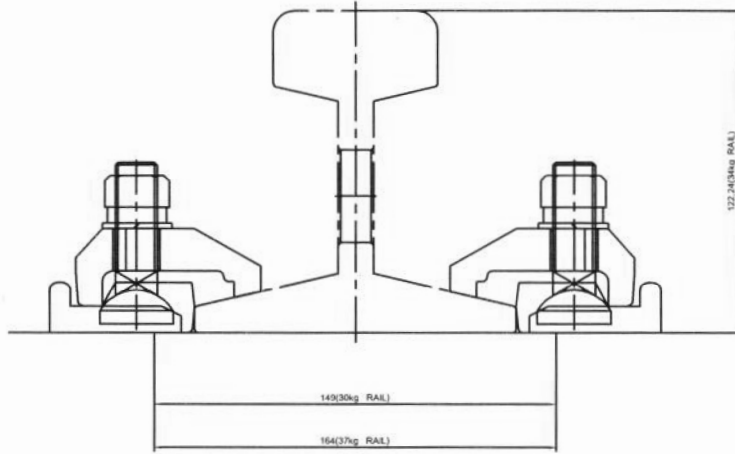
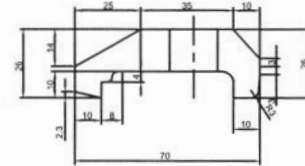
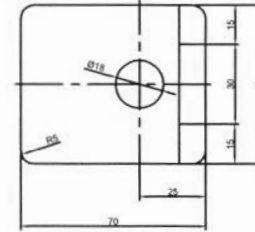

RAIL CLIP 30,37kg 상판

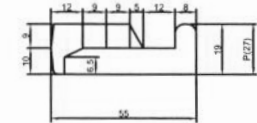
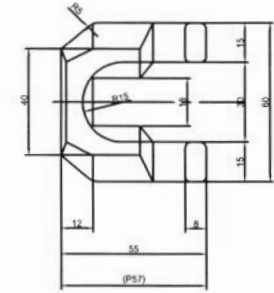

RAIL CLIP 30,37kg 하판

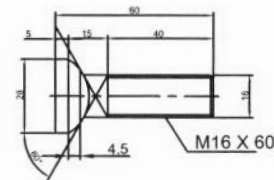

M16 BOLT



M16 NUT

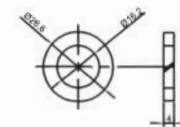
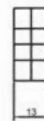

M16 SPRING WASHER

NOTE.
단조품 공차 +1~2/-0.5~1mm
필호치수: pad type

REV	DATE	REASON OF REVISION	PREP'D	CHK'D	RV'D	APP'D
△	-	FIRST ISSUE	-	-	-	-
TITLE						SCALE
FOR 30-37KG/M RAIL						N/S
DOUBLE CLAMP DETAIL						
DRAWN	DESIGNED	CHECKED	APPROVED	REP. DRAWING		
J.H.K	-	-	-			
진호이스트크레인(주)						
T : 031) 353-0300						
F : 031) 353-0053						
JD-DC-30.37-01						

NO.	DESCRIPTIONS	MAT'L	Q'TY	WEIGHT KG.		REMARKS
				UNIT	TOTAL	
	RAIL CLAMP DOUBLE		1	STE		
1	CLAMP UPPER	S20C	1	EA		
2	CLAMP LOWER	S20C	1	EA		
3	BOLE.NUT	S20C	1	EA		

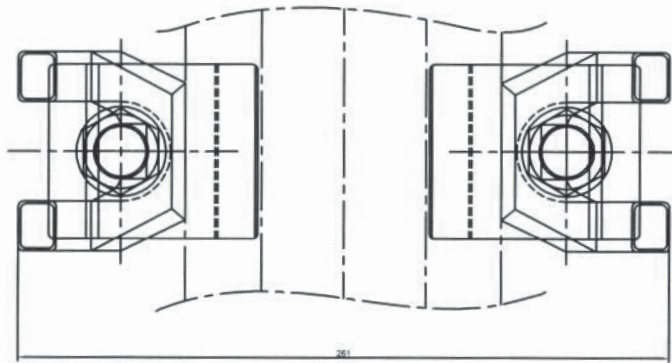
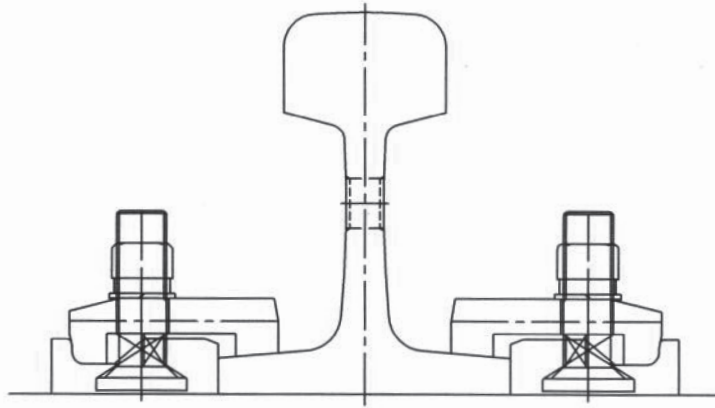

Rail clamp Double Assembly

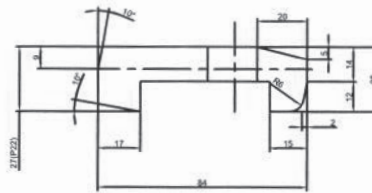
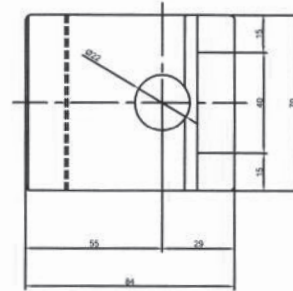

RAIL CLIP 50Kg 상판 ①

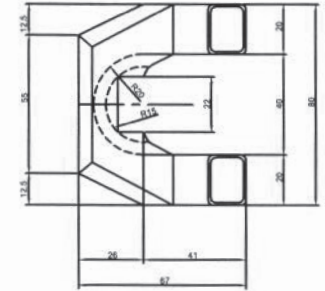
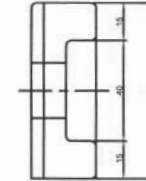

RAIL CLIP 50Kg 하판 ②

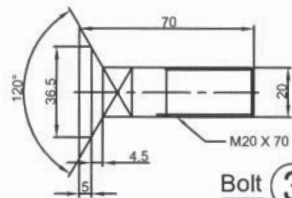

Bolt ③

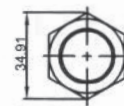
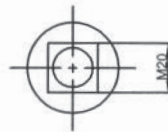

M20 NUT



M20 SPRING WASHER

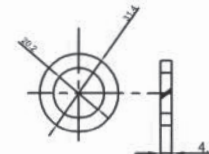

NOTE.
단조철 공차 + mm
괄호치수: pad type

REV	DATE	REASON OF REVISION	PREP'D	CHK'D	RV'D	APP'D	SCALE
△	-	FIRST ISSUE	-	-	-	-	-
TITLE							N/S
For 50KG / M - 1 RAIL							
DOUBLE CLAMP DETAIL							
DRAWN		DESIGNED	CHECKED	APPROVED	REP. DRAWING		
J.H.K		-	-	-			
진호이스트크레인(주)							
T : 031) 353-0300							
F : 031) 353-0053							
JD-DC-50-01							

NO.	DESCRIPTIONS	MAT'L	Q'TY	WEIGHT KG.		REMARKS
				UNIT	TOTAL	
	RAIL CLAMP DOUBLE		1	STE		
1	CLAMP UPPER	S20C	1	EA		
2	CLAMP LOWER	S20C	1	EA		
3	BOLT	S20C	1	EA		

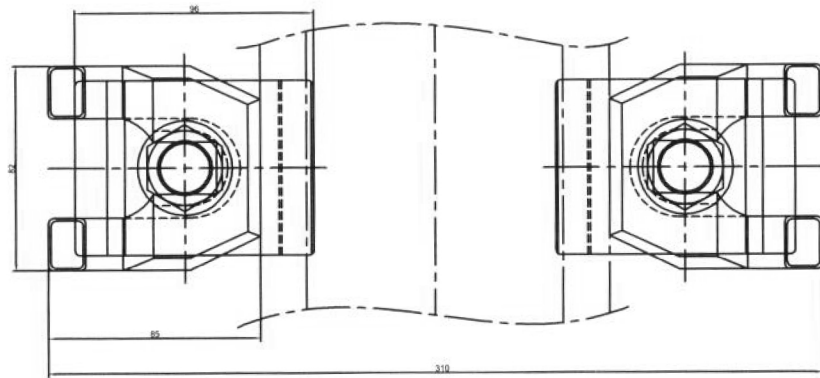
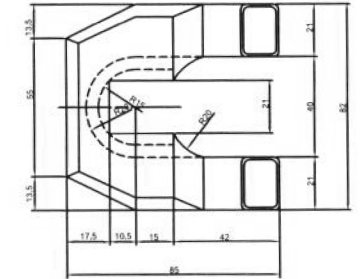
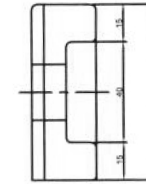
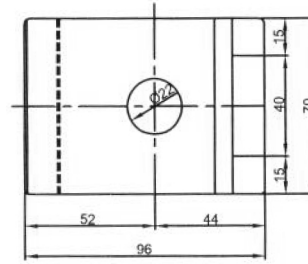
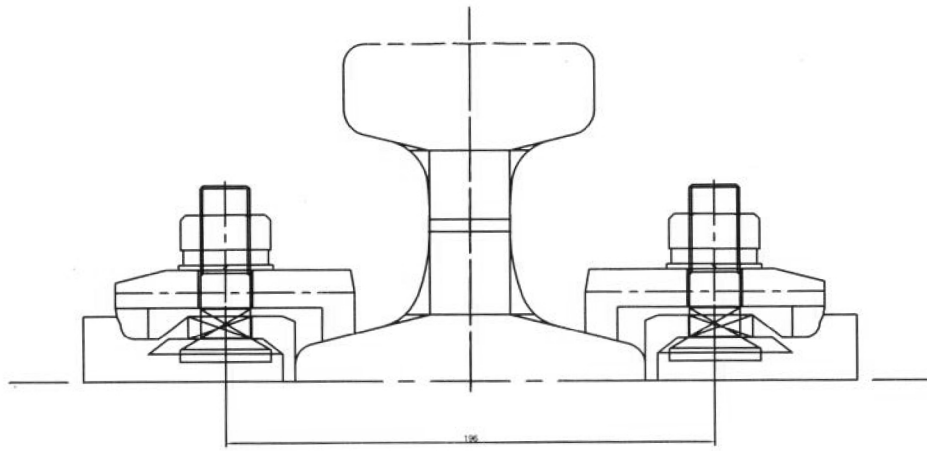

Rail clamp Double Assembly

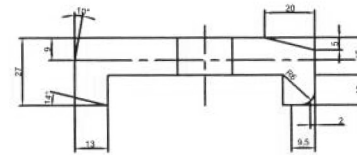

RAIL CLIP 73Kg 상판 ①

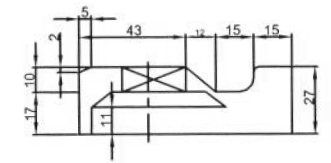

RAIL CLIP 73Kg 하판 ②

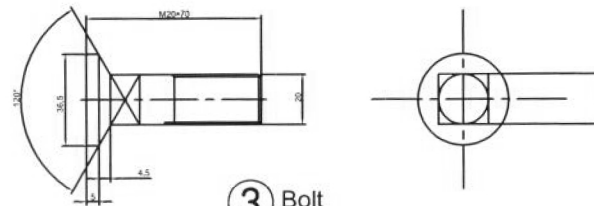

③ Bolt

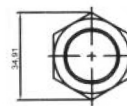

M20 NUT

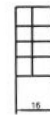

M20 SPRING WASHER

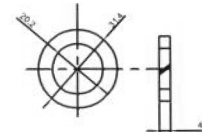

NOTE.
단조품 공차 +1~2 / -0.5~1mm
괄호치수: pad type

REV	DATE	REASON OF REVISION	PREP'D	CHK'D	RV'D	APP'D
△	-	FIRST ISSUE	-	-	-	-
TITLE						SCALE
Foor 73KG / M. RAIL						N/S
DOUBLE CLAMP NO-PAD TYPE DETAIL						
DRAWN	DESIGNED	CHECKED	APPROVED	REP. DRAWING		
J.H.K	-	-	-			
진호이스트크레인(주)						
T : 031) 353-0300						
F : 031) 353-0053						
JD - DC - 73 - 01						